



## USER MANUAL

## Idema Net cleaner Gasoline

F-Drive K-28-280-SB

C	05.12.16	Re-Approved (ECO-0001058)	EBL	IS
B	16.11.15	Re-Approved (ECO-0000829)	EBL	AT / IS
A	15.08.13	Approved	EBL	AT
Rev	Date	Issued	Issued by	Approved by

<b>Document no.:</b>	DC1000924	<b>Document part no.:</b>	10002157
----------------------	-----------	---------------------------	----------

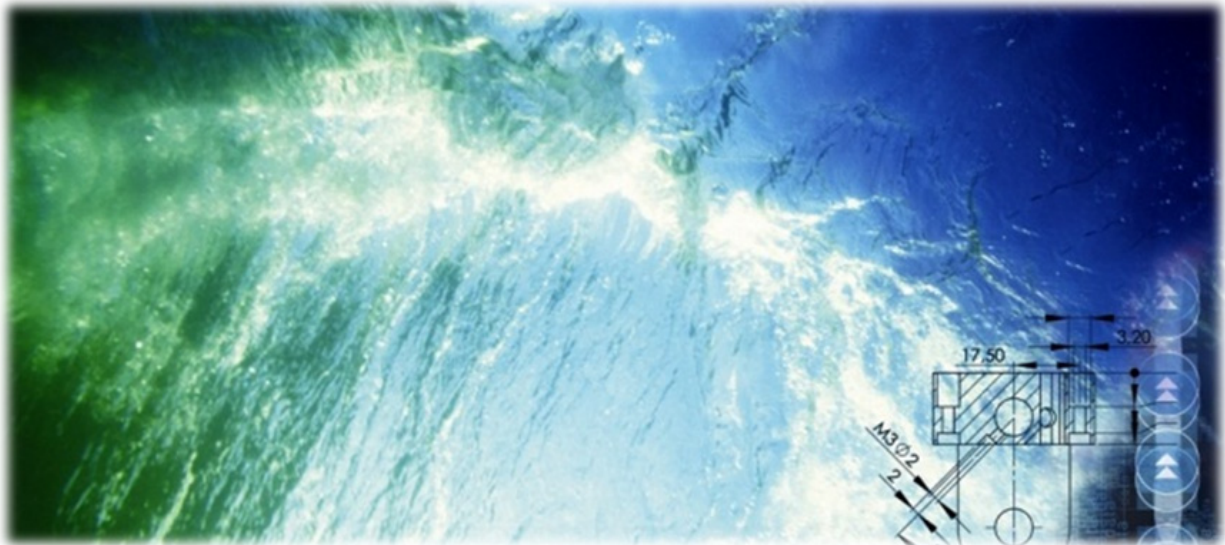

*For a thorough introduction of Your AKVA product, we ask that all users read this entire manual. If questions occur, contact us!*

*The information in this document is subject to change without notice and should not be construed as a commitment by AKVA group ASA.*

*AKVA group ASA assumes no responsibility for any errors that may appear in this document.*

*In no event shall AKVA group ASA be liable for incidental or consequential damages arising from use of this document or of the software and hardware described in this document.*

*We reserve all rights in this document and in the information contained therein. Reproduction, use or disclosure to third parties without express authority is strictly forbidden.*

*This document can also be read and downloaded from our web site, see [www.akvagroup.com/products/user-manuals](http://www.akvagroup.com/products/user-manuals)*

*© 2016 AKVA group ASA (NO)*

## Table of contents

<b>1</b>	<b>Safety .....</b>	<b>5</b>
1.1	Safety symbols .....	5
1.1.1	Other symbols used in this manual .....	5
1.2	Receiving new equipment .....	6
1.3	Personnel .....	6
1.4	Equipment .....	8
1.4.1	General treatment of the equipment .....	8
1.4.2	Storage .....	9
1.5	Inspection before use .....	10
1.6	Disinfecting equipment .....	10
<b>2</b>	<b>Information .....</b>	<b>11</b>
2.1	How to use this manual .....	12
2.2	About AKVA group .....	13
2.3	About Akvasmart Idema Net Cleaners .....	14
2.3.1	Model description .....	16
<b>3</b>	<b>Net Cleaner main components .....</b>	<b>17</b>
3.1	Specifications: engine, gear and pump .....	17
<b>4</b>	<b>Before use .....</b>	<b>18</b>
4.1	General precautions .....	18
4.2	Remove transport plug .....	19
4.3	Oil check .....	19
4.3.1	Motor .....	20
4.3.2	Pump .....	20
4.3.3	Gear .....	20
4.4	Safety valve .....	21
4.5	Hoses .....	22
4.6	Net Cleaner frame .....	22

<b>5</b>	<b>Starting and stopping the machinery .....</b>	<b>23</b>
5.1	Warm up .....	23
5.2	Use .....	24
<b>6</b>	<b>Net Cleaner frames .....</b>	<b>25</b>
<b>7</b>	<b>Cleaning and storage .....</b>	<b>26</b>
7.1	Cleaning after each use .....	26
7.2	Inside washer cleaning .....	28
<b>8</b>	<b>Maintenance .....</b>	<b>29</b>
8.1	Motor .....	29
8.2	Gear .....	29
8.3	Pump .....	30
8.4	Feeding pump .....	30
8.5	Suction filter .....	30
8.6	Net Cleaning frame .....	31
8.7	First time maintenance .....	31
8.8	Daily maintenance registration .....	32
8.9	Weekly maintenance registration .....	33
8.10	Further maintenance registration .....	34
 <b>Appendix A - Index .....</b>		 <b>35</b>
<b>Appendix B - Deviation form .....</b>		<b>36</b>
<b>Appendix C - Notes .....</b>		<b>37</b>
<b>Appendix D - Contact information .....</b>		<b>39</b>

## 1 Safety

Safety for the users of our equipment is top focus when AKVA group ASA develop new products and product manuals.

We therefore strongly recommend that everyone who uses the equipment, all who perform any type of repairs, service or other maintenance to the product, and all who work in areas where the product is installed, read this entire manual and at least this safety chapter.

This recommendation is based on both personnel safety as well as a desire to keep the products in order and avoid the risk of damages as a result of the safety instructions not being followed.

### 1.1 Safety symbols



*Information*



**Show caution, danger of minor personnel injuries and damages to equipment**



**Warning - may cause personnel injuries**



**Danger! Will cause dangerous situations and danger for personnel**

#### 1.1.1 Other symbols used in this manual



Go to or see page or chapter for further instructions or more information

## 1.2 Receiving new equipment

Make sure that all parts are delivered according to the service note. If the order is not complete, or if any defects are discovered, contact AKVA immediately, contact information is found in the back of this manual.

AKVA group ASA offers a 1 year warranty, covering production defects. This warranty is efficient after date of shipment to original customer.

## 1.3 Personnel

All paragraph references in this manual are from "Regulations about high pressure cleaning and more" (In Norwegian: FOR 1992-02-13 nr 1263: Forskrift om høytrykksspyling m.m.). All who are working with or by net cleaners delivered from AKVA group and Idema have to read and understand these regulations and its contents before using the net cleaner.

All personnel must be trained in how to operate the equipment, and also be instructed in all dangers that may occur by improper use. (ref. § 6)

Employer is responsible for informing all personnel about all safety precautions as well as explaining which of the operations may cause personnel injuries. All personnel must be instructed in all of the safety instructions, and it is employers responsibility every employee understands these instructions. (ref. § 7)

Employer must instruct all personnel to use appropriate personal safety equipment and garments when working with and by high pressure systems. Always use antiskid footwear when walking around the cage edge. (ref. § 9)

If the net cleaner operator can not see the pumping aggregate directly, an assisting operator is required. The net cleaner operator must be able to communicate with the assisting operator, preferably visually. (ref. § 22)

Sealing leaks within piping- or hose fittings, must only be performed on depressurized equipment. (ref. § 13)

Employer is responsible of marking all areas where high pressure equipment is being used, as well as securing the danger area properly. (ref. § 23)

When cleaning with manually operated high pressure equipment, only devices with balanced reaction force must be used. Only one diver may stay in the water where the high pressure washer is being used. A diving assistant must control the pumping aggregate, so that the process can be shut down immediately in case of an emergency. (ref. § 26)

Under aged personnel (under 18 years of age) must not operate the washer alone. (ref. Regulations about work performed by children and youth, § 9)

Show general caution when using high pressure equipment. The equipment generates strong forces and may cause severe damage to both personnel and equipment if used incorrectly. When using high pressure net cleaners, the "Regulations about high pressure cleaning and more" (FOR 1992-02-13 nr 1263: Forskrift om høytrykksspyling m.m.), has to be complied. According to § 4 in these regulations, overstepping them is a legal offence.

## 1.4 Equipment

### 1.4.1 General treatment of the equipment

All mechanical and electronic equipment used in the aquaculture industry must be maintained properly in order to function over time and according to expectations, especially in periods when they are being used the most. High pressure washers work in demanding environments with high pressures, large amounts of water and an aggressive corrosive salt water environment. Because of this, following the maintenance instructions are highly required.

Materials that do not require much maintenance are chosen for most of the critical components. Most of the exterior components, however, would be too expensive to produce of corrosion resistant materials. Therefore, rinsing the equipment with fresh water after every use is highly recommended to avoid surface corrosion.

All the movable parts, such as hinges, locks, gas regulators, wheels and such, must be lubricated after rinsing. If scratches or other damages appear in any enameled surfaces, these must be sealed with wax or lubricant immediately in order to prevent further corrosion.

Before using the equipment, always make sure it stands steadily, and if necessary, is securely attached to the foundation to prevent it from slipping and damaging its surrounding equipment or personnel.

If the equipment is going to be moved from one site to another, it is required by law to disinfect the equipment to avoid spread of contagious diseases. Some disinfectants may be aggressive to some metals, o-rings, sealings and other internal components. Therefore, rinse the equipment after use of disinfectants, both inside and outside, with fresh water.



### **1.4.2 Storage**

Do not store the equipment at too high temperatures because of the risk of contagious Legionella bacterial growth within the system. It is advised that the equipment is rinsed off with a narrow beam of fresh water directed away from people after storage.

Salt water drying inside the high pressure pump and components surrounding the pump (suction pump, filters, bypass valve, hoses or other salt water leading components) must be avoided. When this happens, salt crystals are left inside as the water vaporises, and they may cause damage to gaskets and sealings, high abrasion and reduces the equipment's functions. Therefore, if the equipment is going to be stored for more than one week, it is recommended that the entire system is flushed through with fresh water before placing in storage.

For over winter storage, avoid temperatures below the freezing point (100°C and 32°F). It is also recommended to flush the system with a water containing anti-freeze fluid, to prevent the inside water to freeze and possibly destroy the equipment if exposed to freezing-temperatures. The antifreeze solution will also function as lubricant for the system and its internal components.

### **1.5 Inspection before use**

High pressure water represents massive forces, and therefore it is important that critical components are inspected and tested frequently.

Bypass/safety valves are installed at all high pressure equipment to ensure that no higher pressure than the maximal pressure endured by the various components occurs. The safety valve is set to open up for water flow in case the water pressure inside the system exceeds the predetermined level. If any of these valves are out of order when the system runs, this can cause severe damages to the equipment and injure personnel.  
(ref. § 30)

The safety valve is set to a pressure value the equipment endures while in use. Never change this value to a higher pressure. (ref. § 14)

All hoses used in the construction, must be able to endure the working pressure of the equipment. Read the mark on all hoses to make sure they are constructed to bear the desired pressure before using them.

All hoses must be inspected for external damages before each time the net cleaner is being used. If a hose is damaged, it must be replaced or repaired before use.

### **1.6 Disinfecting equipment**

If any of the equipment, cables, ropes or other belonging equipment is being moved to a new location, it is decreed by law to disinfect everything to prevent contamination. We recommend rinsing with fresh water after disinfection, because the disinfectants are strong chemicals that may damage the equipments surface materials.

## 2 Information

Thank you for choosing AKVA group ASA as supplier for Your net cleaning system. Do not hesitate to contact us for more information regarding maintenance for net cleaners or any other AKVA products.

This user manual is part of the equipment delivered with Idema Gasoline Net Cleaners. Keep the manual for as long as Your AKVA products are being used, and make sure that all changes to the equipment are noted in the back of this manual.

The purpose of this manual is to enable the user to use and maintain the Idema Gasoline Net Cleaners in a safe and economical way. This manual will hopefully answer any day-to-day-questions regarding the camera system.

If any necessary information is missing from this manual, please contact AKVA group for assistance and help to find a solution to any problems. Contact the AKVA service department, Your subcontractor, Your local AKVA office or our main office in Norway for assistance and help.

To ensure that the net cleaner equipment is installed correctly, and that all adjustments are performed according to the existing standard in the current country, personnel from AKVA group ASA must attend the first start up of the net cleaner.

## 2.1 How to use this manual

This manual describes how to use and maintain the Akvasmart Idema Gasoline Net Cleaner in the best and safest possible way. This entire manual must be read and understood by ALL users prior to use of the product. Site owner and farm manager are responsible for that all site personnel and users know and understand the contents of this manual.

Before the first chapter, is a table of contents. The headlines may work as links to their respective chapters in the .pdf-file. Chapter 1 is the most important chapter of this manual, and includes safety precautions ensuring safest possible use.

Chapter 2 contains information about AKVA group and the net cleaner, as well as this user manual instruction.

Chapter 3 shows all main parts of and specifications for the Gasoline Net Cleaner. Procedures required before using the net cleaner are explained in chapter 4, and chapter 5 explains how to start and stop the machinery. How to use the net cleaning frame is described in chapter 6, and cleaning and storage procedures are found in chapter 7. Chapter 8 contains maintenance instructions as well as frequency tables and registration forms for maintenance tasks.

Four appendixes are found in the back of the manual: Index, with links to the rest of the manual in the .pdf-document, a deviation form for all deviations with the system, pages for notes about new and extra information are also in the back of the manual and AKVA contact information.



**This entire manual must be read and understood before commencing use of the equipment, as well as used as aid during use, maintenance and other processes**

## 2.2 About AKVA group

With four main brands, AKVA group ASA is a world leading supplier of technical aquaculture equipment. Since 1980 we have developed and produced fish farming equipment, both for cages at sea and for land based hatcheries. AKVA represents an industrial standard, which is presumed to be the turn key to the future. Research, project management, fast deliveries and customer follow-up have been our focus to ensure that we contribute to a positive development within the agriculture industry. Our goal is to deliver the best possible and most cost efficient equipment in order to keep preserving sustainable farming.

We have a wide variety of products, for example: plastic and steel cages, high pressure washers, net washers, boats, feed barges, feeding systems, cameras, sensor systems, under water lighting, software for fish farming and recycling systems.

AKVA has a continuous development of products, and we continue to improve product safety, functions, range of use and reliability. The purpose of this manual is to enable users to use and maintain the Akvasmart Idema Gasoline Net Cleaner in a safe and economic way.

All of our equipment is pre-installed, tested and delivered from our own production department. This means that our customers have total control over which components you can choose from, grouping collocation, testing and deliveries. Our production staff consists of people with great expertise and engagement for producing the best possible products. Having our own production site provides excellent service in case something should go wrong, or if assistance is required. Our service staff is available over telephone or on location to assist whenever necessary.

Safety, both for users and equipment is main focus when AKVA group develops products and product manuals.

### **2.3 About Akvasmart Idema Net Cleaners**

Idema Net Cleaners were launched in 1987, and are today renowned for quality, high performance and their ease of use. The first Net Cleaners had single 30cm diameter cleaning discs, operated from the cage edge using a shaft. Underwater pressure cleaning of cages where fish reside, has become even more common as the requirement to environmentally friendly aquaculture in larger cages provides the best scale of economics. AKVA have developed and improved the Akvasmart Idema Net Cleaners, and can now present the best range of net cleaners and high pressure pumps ever. This combination offers the most efficient cleaning system suited for all types and sizes of cages.

In net cleaning, filtered high pressure sea water is used to remove marine fouling on the nets. Akvasmart Idema Net Cleaners use rotating cleaning discs mounted on support frames in various shapes and combinations. We use rugged, tailor-made high pressure pumps to run the cleaning discs. The cleaning process starts with submerging the frame in the inside of the net, using high pressure sea water. Idema cleaning systems do not use any chemicals or scrubbing action, making them environmentally friendly and ensuring minimal wear on the net.

The large net cleaners can be operated automatically by two persons using a crane, winch, cap stand or as an integrated option on a ROV (Remotely Operated Vehicle). The smallest net cleaners can easily be operated from the cage edge by a single person. Larger net cleaning frames can be delivered with cameras and recording systems that give full overview over the cleaning process, and makes it possible to inspect the net as it is being cleaned.

All our net cleaning products are produced according to these standards and procedures:

- ISO-EN 12100 Part 1&2: Safety of machinery
- EC-Directive 98/37/EC: Machinery Directive
- EC-Directive 97/23/EC: Pressure Equipment

**Gasoline, diesel or hydraulic driven net cleaners**

AKVA group offers a rugged series of high pressure washers for seawater, suited for various system solutions and cage sizes.

The gasoline net cleaners are light-weight and perfect as portable units.

The diesel net cleaners are almost maintenance free, use less fuel than the gasoline models and are well suited for large, powerful, permanent installations.

The hydraulic net cleaners are small, compact and almost maintenance free, perfect for below deck installations in service boats.

**Net cleaning frames**



• 270 cm



• 270 cm

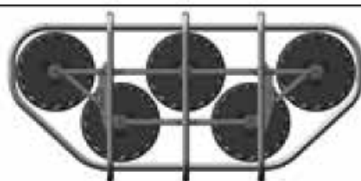

• 180 cm



• 180 cm



• 90 cm



• 30 cm (modell med skaft)

The Idema Heavy Duty Cleaning discs are equipped with stainless steel frames. The discs have a rotation speed from 750-1500 rpm.

### 2.3.1 Model description

All high pressure net cleaners delivered by AKVA group have a uniform model description. The description contains information about machinery, capacity and function. Example:

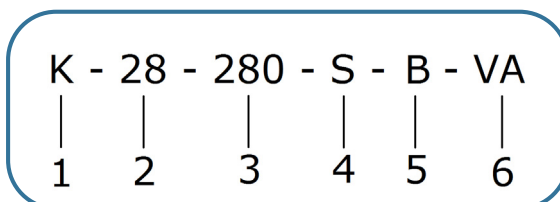

1 K = Cold water, V = Hot water

2 Liter water per minute

3 Water pressure (bar)

4 Water supply: S = Integrated suction pump  
X = Without suction pump

5 Motor type: H = Hydraulic  
B = Gasoline  
E = Electro  
D = Diesel

6 Motor fabrication: CO = Comer  
VA = Vanguard  
HO = Honda  
HZ = Hatz  
IV = Iveco  
JD = John Deere  
SU = Sunfarb

7 Volume/effect: B og D - effect in Hp  
E - effect in kW  
H - Vol.=ccm/rev



### 3 The net cleaner main components

A: Engine
B: Gear
C: Pump
D: High pressure hose
E: Suction hose with filter
F: Gasoline tank
G: Carriage
H: High pressure pistol



Figuren kan avvike noe fra virkeligheten

#### 3.1 Specifications: engine, gear and pump

Engine: Petrol Vanguard 16.4 kW (22Hp)

Gear: PA 25.4mm axle 2.276:1 13-17kW

Pump: 2530PTO dual shaft



*For further information on engine, gear and pump, see their respective user manuals*

## **4 Inspection before use**

High pressure water represents major forces, and it is therefore important to inspect and test critical components frequently. Before using this net cleaner, always make sure that it stands steadily, and if necessary, is fastened to the foundation to prevent moving around, thus reducing the risk of injury to personnel and damaging surrounding equipment.

### **4.1 General precautions**

Show general caution when using high pressure equipment. Net cleaners generate major forces, and may cause damages to both personnel and equipment if used incorrectly. Regular controls and maintenance is important, make sure to follow all instructions in this manual to ensure best possible safety and longest possible operating time for the net cleaner.

It is very important to get familiar with this manual and its contents, and especially instructions for safety, use and maintenance of the equipment before using it. This reduces risk of damages to personnel, net cleaner and surrounding equipment during use of the net cleaner.

Bypass valves are set to open for water flow if the water pressure exceeds the determined level. If this does not function as it should, the equipment may blast and be destroyed, and it may also cause damages to personnel and surrounding equipment.

## 4.2 Remove transport plug

When net cleaners are transported, gear and pump are plugged with a special transport plug to prevent oil leaking. The net cleaners are not ment to be operated with transport plugs.

If transport plug, red top, is installed in gear or pump when receiving the net cleaner, remove these, and replace with normal yellow top or dip stick top. Keep the red tops for potential transport later.

**Remove this:**



**Attach this:**



## 4.3 Check oil levels

Use oil see glass or dipstick to control oil level in net cleaner gear, motor and pump.

### Dip stick

The oil level is shown in the sticks end, and should be between the two lines. If the level is below the bottom line, the engine needs more oil. If the level is over the top line, oil must be tapped from the engine.

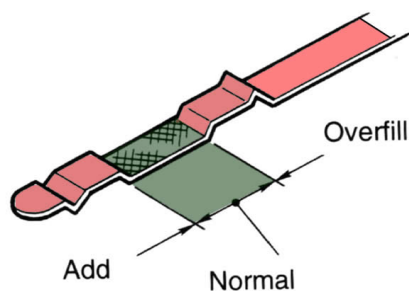

### 4.2.1 Motor

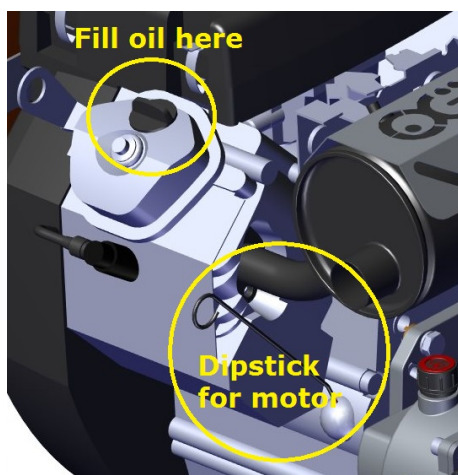

Use the dipstick to check the motoroil level.  
The dipstick is found on the right side of the motor when standing behind the fuel tank.

### 4.2.2 Pump

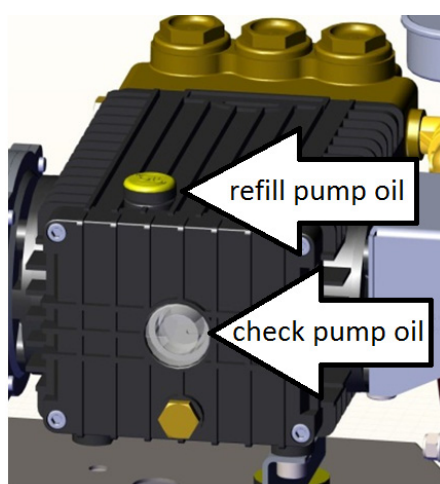

Pump oil level is checked in the see glass on the pumps left side. The oil see glass is found on the right side of the motor when standing behind the fuel tank. The oil level in the see glass should be around half full.

If refill is needed, open the lid on top of the pump and fill little by little here, check the see glass in between. Use a funnel to avoid spilling oil all over the gear box.

### 4.2.3 Gear

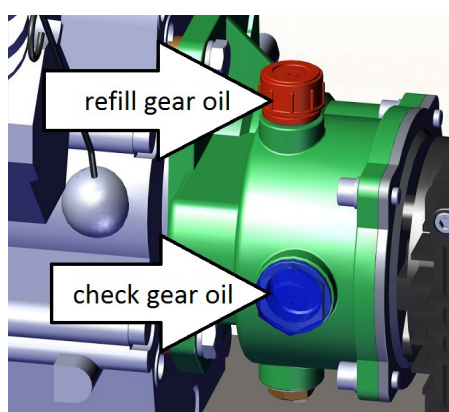

Gear oil is checked in the oil see glass placed on the net cleaners right side when standing behind the fuel tank. The oil level in the see glass should be around half full.

If refill is needed, open the lid on top of the gear and fill little by little here, check the see glass in between. Use a funnel to avoid spilling oil all over the gear box.

#### 4.4 Safety/Bypass valve



One or more safety valves are always installed in all high pressure equipment to ensure that the pressure inside the system does not exceed the highest bearable pressure for any of the components. Safety valves are set to open for water flow if the pressure exceeds the predetermined level. The net cleaner may be damaged if the safety valve is not functioning as it should, and this may also cause personnel injuries and damages to surrounding equipment as well.

The predetermined pressure inside the safety valve must never be changed!

Use a high pressure pistol before the first time the net cleaner is being used to ensure that everything functions as it should. Also use a high pressure pistol for testing the safety valve, see chapter 5 for instructions.

Attach the pistol to the net cleaner, and start the net cleaner as instructed in chapter 5. Water *should not* exit the outlet hose when the pistol is being used, and water *should* exit the hose when the pistol is not being used. If deviations occurs, this may indicate that something is wrong:

- Something may be wrong with the valve itself. In that case, it has to be overhauled or changed before use
- The pressure may be higher than the parts allows, which makes the safety valve react. The most common cause of this is that one or several nozzles in the net cleaner are clogged. Check these and rinse if clogged
- Control all hoses, including the ones on the net cleaning frames for bends, and flatten if bent

Contact AKVA service personnel if a problem can not be solved according to these instructions. Contact information is found in the back of this manual.



## 4.5 Hoses

All hoses used with this high pressure washer must be constructed in order to bear the working pressure of the equipment. Make sure the hose you are using can bear this pressure, by reading the labelling on the outside of the hose. Hoses also need to be inspected for tears and other damages. In case of damage, replace or repair the hoses before use.

Make sure that the suction hose is attached properly to the feeding pump, and that the entire filter is under water when starting up the system.

The net cleaner must never be run without filter attached to the inlet hose. Check the filter cloth for damages and tears, and replace it if it has any tears or major wears. If a damaged filter is being used, unwanted elements may enter the system and clog it, causing damages to and problems with both the pump and the pumps surrounding components.

## 4.6 Net cleaner

Check the hoses on the net washer for bends, these hoses should be flattened if bent.

Check for tears and other destructions in the net cleaner. These damages should be repaired, or else the hoses must be replaced before use.

Check the hose couplings, and tighten if necessary.

Check all nozzles before use. If these are clogged, the water pressure will be significantly reduced, and the pressure inside the system will exceed, and the risk of damages to surrounding equipment will increase.

## 5 Starting and stopping



After completing the inspections in chapter 4, the net cleaner is ready for use. First, it has to be properly warmed up, and thereafter to be used for cleaning cage nets. Do not use a net cleaner before it has been properly warmed up as described below.

### 5.1 Warm up

The high pressure hose must not be used before it is warmed up properly. Follow these instructions for warming it up:

1. Fill the tank **(1)** with 95 octane unleaded gasoline
2. Pump the gas hose bellow pump **(2)** 4-5 times
3. Set the choke **(3)** to full effect (the choke is placed on the side of the engine, under the tank)
4. Set the treadle **(4)** to 30% effect (this treadle is placed in the back of the engine)
5. Set the switch **(5)** in start position
6. Pull the starting cord
7. Turn the choke off immediately after the engine starts up
8. Check that the washer sucks water through the suction hose, and that the water is let out from the outlet beside the safety valve **(6)**
9. Let the engine run at low rpm for 5 minutes
10. Turn the engine off with the switch

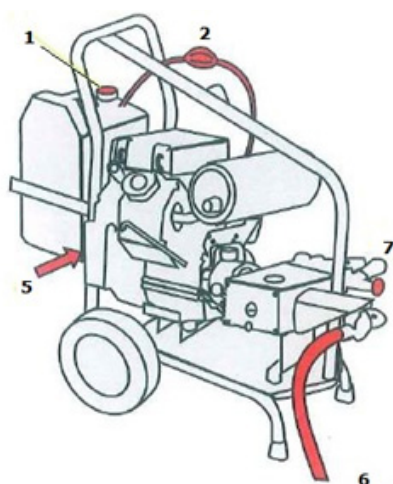

- 1 Fuel tank
- 2 Gasoline engine bellow pump
- 3 Choke
- 4 Treadle
- 5 Start/stop-switch
- 6 Suction hose
- 7 Bypass valve

## 5.2 Use



After warming up the net cleaner engine according to instructions in chapter 5.1, it may be used for cleaning nets.

Before use, test the net cleaner by using a high pressure pistol:

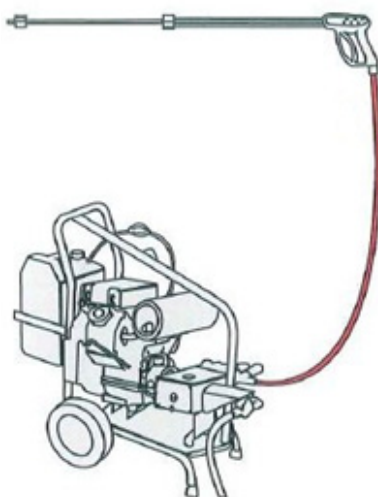

- 1 Connect the high pressure pistol to the net cleaner hose
- 2 Connect the net cleaner hose to the outlet beside the bypass valve
- 3 Press the pistol handle as the system starts up
- 4 Set the power treadle to about 30%
- 5 Start the engine by pulling the

Start When the engine runs on full rpm, the system is supposed to perform 260-280 bars with either:

- with nozzle marked 25065 (pistol), or
- with 8 0.5mm and 2 0.6mm nozzles in the Dual head 400HD net cleaner



## 6 Net cleaning frames



**Safety equipments such as antiskid footwear and floating garments is mandatory when working on the cage edge**

Attach the rope for lowering and lifting the frame via a safety hook to prevent tearing on the rope.

The cleaning process is most efficient when the frame is being pulled upwards. When going down in the water, the frame will not sink controlled and will not be cleaning very efficiently. So, whether using crane or manual labour when cleaning nets with high pressure cleaners, lower the frame as controlled as possible to the bottom of the net, avoid disturbing the fish. Then raise it slowly and controlled to achieve best possible result.

The frame must always be held under water when the machinery is running. For testing the nozzles, however it can be run above water, but only using feed pressure.

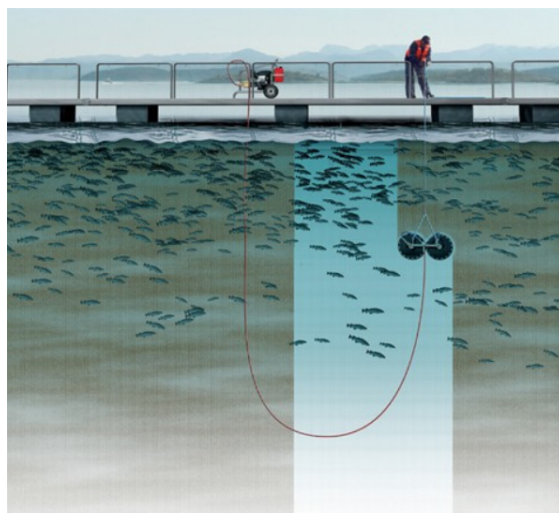

## **7 Cleaning and storage**

Regularly service and well performed maintenance are factors which will prolong the net cleaner lifetime and functions. All tasks in the maintenance plan must be executed according to plan and as instructed.

By following the instructions in this manual, the equipment will always be ready for use, and this will also reduce the service costs.

### **7.1 After use and before storage**

Avoid leaving salt water to dry off inside the system, rinse with fresh water after use to prevent corrosion and other damages caused by salt crystals on metals and other materials.

We recommend a rinse with fresh water if the washer is going to be stored for one week or more.

Also, rinsing the outside with fresh water regularly prevents corrosion on the surfaces. All moving parts, such as hinges, wheels, locks and gas regulators, must be lubricated after each fresh water rinse. Check every surface covered with enamel for scratches, and fill these with 20 lubricant to avoid further corrosion. If, before moving, the equipment is disinfected, it has to be rinsed off with fresh water, and lubricant/wax added as mentioned above.

If the system can be exposed to frost, it is important that the amount of water inside is as low as possible, but more importantly, there has to be anti-freeze liquid mixed in the water. The components can break if a large amounts of water freezes inside.

### **Cleaning procedures**

- Keep the machinery clean, dry and in order
- Wash away any spills of oil immediately
- Do not use high pressure cleaners to clean this equipment, this can cause water intruding into the engine, pump, gear and electronics, and ruining these components
- Use a mild detergent, do not use strong degreasers
- The entire machine is inserted with protection wax in order to reduce corrosion. After cleaning the outside of the machinery, always apply a new layer of protection wax. If this wax is applied when the machine is still warm, it sticks better, and therefore stays on longer
- Before storage in cold environments, the insides of the system has to be rinsed through according to the following procedure:
  - 1 Always run fresh water through the system after use
  - 2 Mix 80/20 water with antifreeze solution and run this through the system to conserve the system, to lubricate the seals and to reduce the danger of frost damages in case of storing in a below 0° C environment. If storing in colder environments, increase the amount of antifreeze solution. Check instructions on the solution bottle
  - 3 If there is a slight chance that the system will be exposed to frost during storage, it is also very important to drain all water to avoid components breaking, as water expands when freezing. Run the system for up to 10 seconds with the suction hose above water to drain.
  - 4 Empty the pressure hose and coil it up.

## **7.2 Nozzles and ejector intake**

Leave net cleaning frame or high pressure pistol connected to the system as it is rinsed through with fresh water and/or anti freeze solution. These parts also need to be rinsed through.

Control nozzles and clean if necessary:

- high pressure pistol
- net cleaner frame and frame.

Net cleaner frame ejector intakes also have to be controlled and cleaned when necessary.

Remove any filth and fouling from the discs in the net cleaning frame. Clean all sides, and especially the back side and between the discs and the plastic cover and the hubs.

## 8 Maintenance

Regular maintenance performed on any equipment will provide expected results with every use, as well as prolong operating time for any properly maintained product.

Contact our service department if any questions that are not answered in this manual occur, or if assistance is desired for executing maintenance or any other tasks.

Motor and pump oil, and motor air filter must be changed for the first time after only 5 hours use. Hereafter, these require change every 100 hours. This, and other first time maintenance tasks are registered in the form in chapter 8.7.



Register all performed maintenance tasks in the registration form in chapter 8.8. Sign with initials, and make sure to also register the time for next times maintenance.

### 8.1 Motor

Motor oil: 1.40 liters 10W-40

Oil change: first after 5 hours, then every 100 hours

Change oil filter: first after 5 hours, then every 100 hours

Oil check: daily

Exterior cleaning: weekly

Check/change air filter: weekly/when necessary

### 8.2 Gear

Gear oil: 0.35 liter 80W-90

Oil change: first time after 50 hours, then every 100 hours

Oil check: daily

Exterior cleaning: weekly

### **8.3 Pump**

Pump oil: 1.40 liters 10W-40

Check oil: every day

Change oil: first after 50 hours, then every 100 hours

Exterior cleaning: weekly

Impeller function test: once a year

Check/change vents: weekly/when required

Check/change pressure gaskets: weekly/when required

Check/change pistons: weekly/when required

### **8.4 Feeding pump**

Impeller inspection\* : when required, or at least once a year

Change impeller: when required

Change bearings: when required

Change gaskets: when required

\* Impeller is inspected visually by removing the cover and looking inside to see if everything looks ok

### **8.5 Suction filter**

The sea water filter is visually inspected once a month

Cleaning/change: when required

### 8.6 Net cleaning frame

Change bearings when required. Swirl the discs and listen for rumbling sounds. If the bearings are ok, no sound will appear. Are there any noise, the bearings need to be changed.

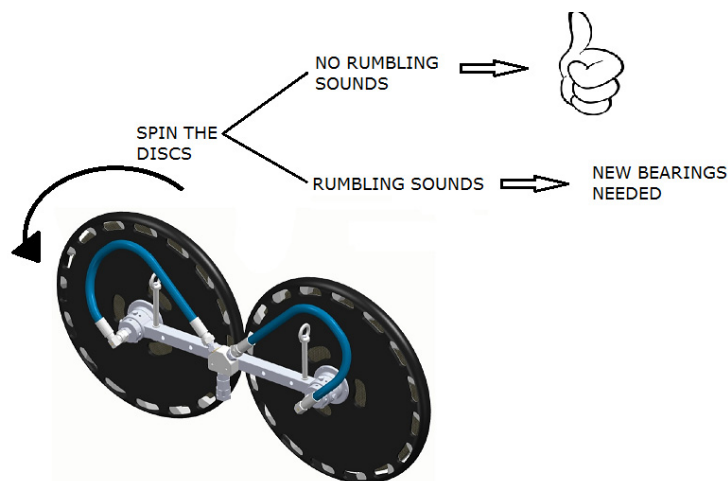

Run the system with feeding pressure above water to control the nozzles condition. Clean or replace nozzles when required.

Hoses and hose couplings needs to be checked every six months.

### 8.7 First time maintenance

Execute these parameters as described in the manuals for motor, pump and gear. Sign the form after the task is executed, and register further maintenance with other maintenance tasks in the registration form in chapter 8.10.



Maintenance parameter	Check/change after	Executed date	Executed by (signature)
Change motor oil	1 week		
Change motor oil filter	50h		
Change pump oil	1 day		
Change gear oil	1 year		

### 8.8 Daily maintenance



*Make copies of this form before filling anything out  
Sign in correct box after the task is performed*

<b>Week ____</b>	<b>Mon</b>	<b>Tue</b>	<b>Wed</b>	<b>Thu</b>	<b>Fri</b>	<b>Sat</b>	<b>Sun</b>
Check motor oil							
Check pump oil							
Check gear oil							

<b>Week ____</b>	<b>Mon</b>	<b>Tue</b>	<b>Wed</b>	<b>Thu</b>	<b>Fri</b>	<b>Sat</b>	<b>Sun</b>
Check motor oil							
Check pump oil							
Check gear oil							

<b>Week ____</b>	<b>Mon</b>	<b>Tue</b>	<b>Wed</b>	<b>Thu</b>	<b>Fri</b>	<b>Sat</b>	<b>Sun</b>
Check motor oil							
Check pump oil							
Check gear oil							

<b>Week ____</b>	<b>Mon</b>	<b>Tue</b>	<b>Wed</b>	<b>Thu</b>	<b>Fri</b>	<b>Sat</b>	<b>Sun</b>
Check motor oil							
Check pump oil							
Check gear oil							

<b>Week ____</b>	<b>Mon</b>	<b>Tue</b>	<b>Wed</b>	<b>Thu</b>	<b>Fri</b>	<b>Sat</b>	<b>Sun</b>
Check motor oil							
Check pump oil							
Check gear oil							



### 8.9 Weekly maintenance



*Make copies of this form before filling anything out  
Sign in correct box after the task is performed*

Month_____	Week___	Week___	Week___	Week___
Clean net cleaner exterior				
Check* motor air filter				
Check* pressure gaskets in pump				
Check* vents and pistons in pump				

Month_____	Week___	Week___	Week___	Week___
Clean net cleaner exterior				
Check* motor air filter				
Check* pressure gaskets in pump				
Check* vents and pistons in pump				

Month_____	Week___	Week___	Week___	Week___
Clean net cleaner exterior				
Check* motor air filter				
Check* pressure gaskets in pump				
Check* vents and pistons in pump				

Month_____	Week___	Week___	Week___	Week___
Clean net cleaner exterior				
Check* motor air filter				
Check* pressure gaskets in pump				
Check* vents and pistons in pump				

*\* Check also means change when required*

**8.10 Maintenance registration**

*Make copies of this form before filling anything in  
Sign with your initials after the task is executed*

<b>Date</b>	<b>Parameter description</b>	<b>Operating hours</b>	<b>Time for next</b>	<b>Signature</b>

## Appendix A - Index

### A

antifreeze solution 9, 27  
antiskid footwear 6, 25

### C

cleaning discs 14, 15  
corrosion 8, 26, 27

### D

disinfect 8, 10, 26

### F

feeding pump 22, 30  
fresh water 8-10, 26-28

### G

gaskets 9, 30, 33

### H

hose couplings 22, 31

### L

lubricant 8, 9, 26, 27

### N

nozzles 21, 22, 24, 25, 28, 31

### O

oil see glass 19, 20  
outlet hose 21

### P

pistol 17, 21, 24, 28  
pressure hose 17, 23, 27

### S

safety hook 25  
safety valve 10, 21, 23  
salt water 8, 9, 26  
suction filter 9, 17, 22, 30

### T

temperature 9

### W

water pressure 10, 14, 16, 18, 22  
wax 8, 26, 27  
winter storage 9, 27  
working pressure 10, 22

## Appendix B - Deviation form



*Make copies of this form before filling anything in*

<b>Deviation no.:</b>	
-----------------------	--

<b>Unit:</b>	<b>Producer:</b>	<b>Prod.no.:</b>	<b>Purchase year:</b>

<b>Deviation description:</b>
-------------------------------

--

<b>Follow up proposition:</b>
-------------------------------

--

<b>Date and signature, declarer:</b>
--------------------------------------

--

<b>Follow up directed:</b>
----------------------------

--

<b>Status:</b>
----------------

--

<b>New action for deviation no.:</b>
--------------------------------------

--

<b>Date and signature, follow up:</b>
---------------------------------------

--





## Appendix D - Contact information

### **NORWAY - AKVA group ASA**

#### **Head Office**

Nordlysveien 4

PO. Box 271

N-4340 Bryne

Norway

tel. +47 - 51 77 85 00

fax. +47 - 51 77 85 01

Support Hardware and AKVAconnect

tel. + 47 - 51 77 85 03

[supportakvasmart@akvagroup.com](mailto:supportakvasmart@akvagroup.com)

Support Fishtalk

tel. +47 - 73 84 28 20

[supportfishtalk@akvagroup.com](mailto:supportfishtalk@akvagroup.com)

### **DENMARK**

AKVA group Denmark AS (Land Based)

Bødkervej 7A, 1.

7000 Fredericia, Denmark

t. +45 7551 3211

f. +45 7551 4211

AKVA group Denmark AS (Land based)

Roskildevej 342, Building 2

2630 Taastrup, Denmark

t. +47 7551 3211

### **SWEEDEN**

AKVA group - Agent: Modus Trading AB

Färjegårdarne 7

78461 Borlänge, Sweden

t. +46 - (0)243 883 22

f. +46 - (0)243 21 17 78

[modus@dalnet.se](mailto:modus@dalnet.se)

### **FINLAND**

AKVA group - Agent: OY MG Trading AB

Ivisnäsplanen 2E

SF-02260 Esbo, Finland

t. +358 - 9867 68422

f. +358 - 9867 68420

### **ICELAND**

AKVA group - Agent

Wise lausnir ehf

Borgartun 26, 105 Reykjavik, Iceland

t. + 354 545 3200

f. +354 545 3232

### **UK (SCOTLAND)**

AKVA group Scotland Ltd.

36F Shore Street

Inverness, Scotland, UK

IV1 1NF

t. +44 (0)1463 221 444

f. +44 (0)1463 223 535

**GREECE**

Akvasmart/Fishtalk - Agent:  
Zellas Trading Company  
Dodekanisou Str., GR-174 56  
Alimos, Athens, GREECE  
t. +30 - 210 7014881  
f. +30 - 210 7012666  
[zellastrading@ath.forthnet.gr](mailto:zellastrading@ath.forthnet.gr)

**TURKEY**

AKVA group Kültür  
Balıkçılığı Ekipmanları Ltd. Şti.  
Yeni Küçük Sanayi Sitesi No:1-C19 Baharlı Köyü  
48200 Milas, Muğla, TURKEY  
t. +90 - 252 - 374 - 6434  
f. +90 - 252 - 374 - 6432

**TUNISIE**

AKVA group - Agent: Société Méditerranéenne  
d` Etudes et Conseils  
72, Avenue Habib Bourguiba  
2080 Ariana, Tunisie  
t. +216 71 700 453  
f. +216 71 700 297  
[smechg@gnet.tn](mailto:smechg@gnet.tn)

**CANADA**

AKVA group North America Inc.  
1495 Baikie Road, Campbell River  
BC, V9W 1R9 Canada  
t. +1 - 250-286-8802  
f. +1 - 250-286-8805

AKVA group North America Inc.  
5251 Duke Street, Suite 606, Duke Tower,  
Scotia Square  
Halifax, NS, B3J 1P3 Canada  
t. +1-902-482-2663  
f. +1 - 902-405-3373

**CHILE**

AKVA group Chile  
Ruta 5 Sur Km.  
1030, Puerto Montt, Chile  
t. +56 - 65 250250  
f. +56 - 65 257119

**AUSTRALIA**

AKVA group Australasia  
t. +61 400 167 188  
[cschafer@akvagroup.com](mailto:cschafer@akvagroup.com)